

FIG 4

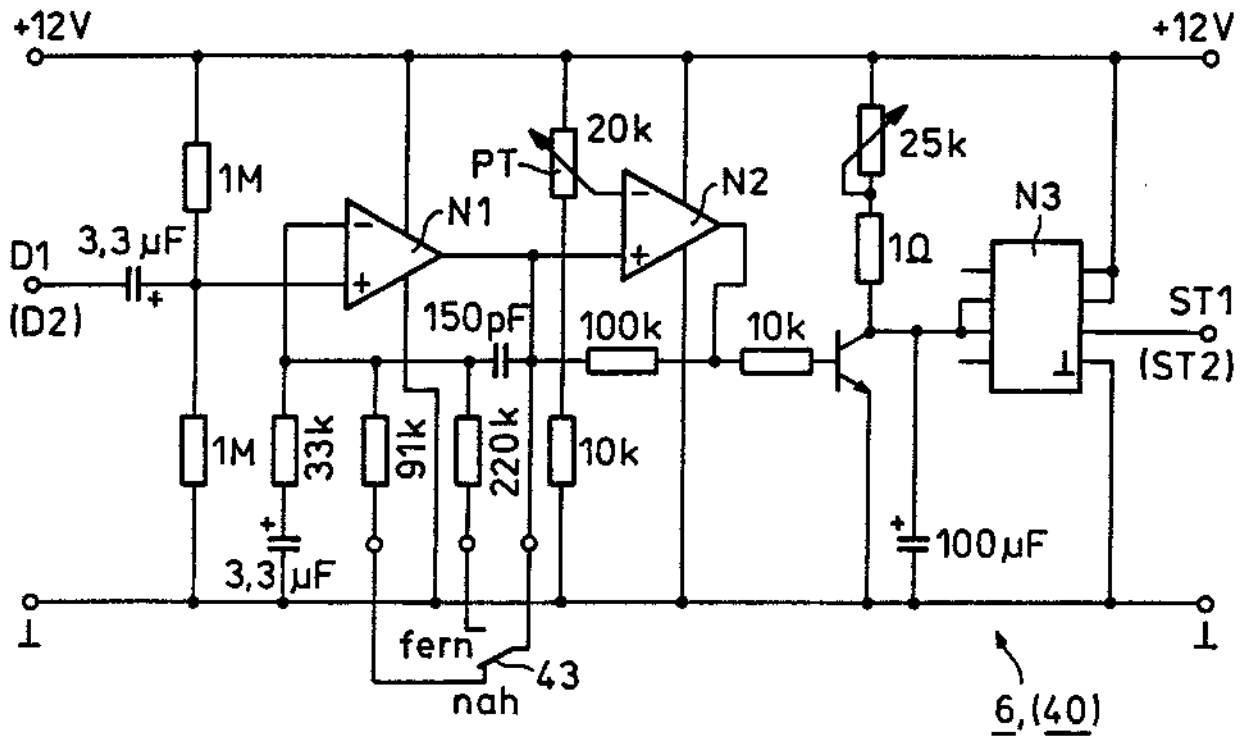

FIG 5